

## BH-0.66 III 型电流互感器

### 1 适用范围

BH-0.66III型电流互感器主要用于户内，供额定电压为0.66kV及以下，额定频率为50Hz的交流电路中作为电流、电能测量或继电保护用。产品为塑壳式电流互感器，广泛应用于成套柜体，其安装方法可采用母排固定和底板固定安装方法，适合任意方向安装，与I、II型相比具有容量大、精度高、附件少、安装方便等优点。

符合标准：GB 20840.2。

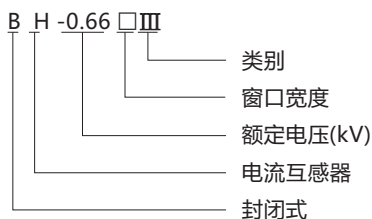

### 2 型号及含义







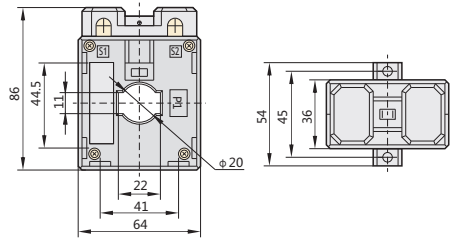

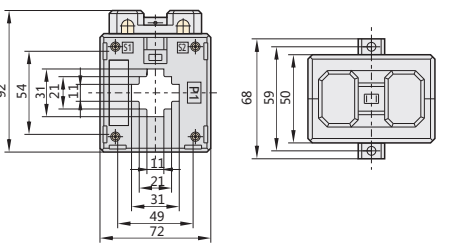
### 3 正常工作条件和安装条件

- 3.1 安装场所：户内。
- 3.2 环境温度：-5℃~40℃。
- 3.3 环境湿度：相对湿度不大于80%。
- 3.4 海拔高度：不超过1000m。
- 3.5 大气条件：大气中无严重污秽。

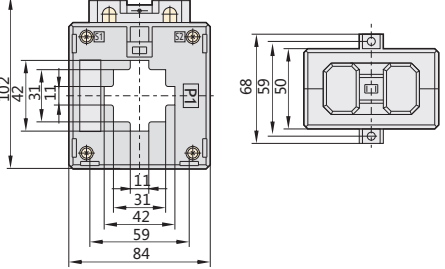

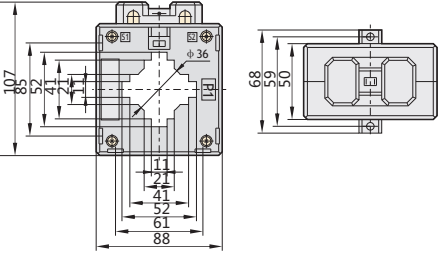

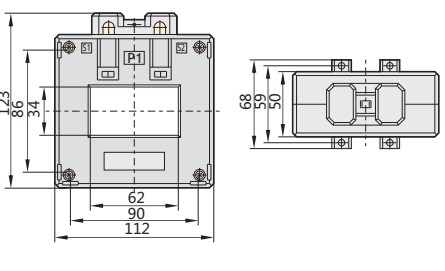
### 4 主要技术参数及外形安装尺寸

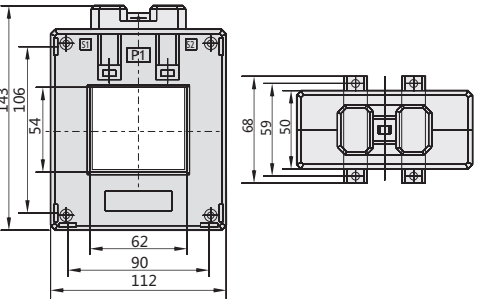
	电流比A	额定输出VA(二次电流1A:Ω)				穿心匝数	外形及安装尺寸
		1级	0.5级	0.5S级	0.2级		
 <p>BH-0.66 20 III</p>	75/5	2.5				1	
	100/5	5				1	
	150/5	10	5			1	
	200/5	10	5			1	
	75/1	2.5	1			1	
	100/1	2.5	1			1	
	150/1	10	5			1	
 <p>BH-0.66 30 III</p>	150/5	10	5	5	5	1	
	200/5	10	5	5	5	1	
	250/5	10	5	5	5	1	
	300/5	10	5	5	5	1	
	400/5	10	5	5	5	1	
	500/5	10	10	10	10	1	
	150/1	10	5			1	
	200/1	10	5			1	
	250/1	10	5			1	
	300/1	10	5			1	
	400/1	10	5			1	

# 配电电器

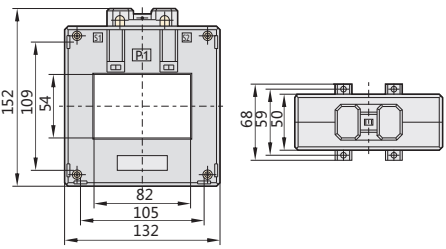
电流比A	额定输出VA(二次电流1A : Ω)				穿心匝数	外形及安装尺寸			
	1级	0.5级	0.5S级	0.2级					
	150/5	10	5		1				
	200/5	10	5		1				
	250/5	10	5		1				
	300/5	10	10	5	5		1		
	400/5	10	10	5	5		1		
	500/5	10	10	10	10		1		
	600/5	10	10	10	10		1		
	750/5	10	10	10	10		1		
	800/5	10	10	10	10		1		
	1000/5	10	10	10	10		1		
	150/1	10	5				1		
	200/1	10	5				1		
	250/1	10	5				1		
	300/1	10	5				1		
	400/1	10	5				1		
	500/1	10	10				1		
600/1	10	10			1				
750/1	10	10			1				
800/1	10	10			1				
	300/5	10	10		1				
	400/5	10	10		1				
	500/5	10	10	10	10		1		
	600/5	10	10	10	10		1		
	750/5	10	10	10	10		1		
	800/5	10	10	10	10		1		
	1000/5	10	10	10	10		1		
	1200/5	20	20	20	20		1		
	300/1	10	5				1		
	400/1	10	5				1		
	500/1	10	10				1		
	600/1	10	10				1		
	750/1	10	10				1		
	800/1	10	10				1		
	1000/1	10	10				1		
		500/5	10	10	10		10	1	
600/5		10	10	10	10	1			
750/5		10	10	10	10	1			
800/5		10	10	10	10	1			
1000/5		10	10	10	10	1			
1200/5		20	20	20	20	1			
1500/5		20	20	20	20	1			
500/1		10	10			1			
600/1		10	10			1			
750/1		10	10			1			
800/1		10	10			1			
1000/1		10	10			1			
1200/1		20	20			1			
		500/5	10	10	10	10	1		
		600/5	10	10	10	10	1		
		750/5	10	10	10	10	1		
	800/5	10	10	10	10	1			
	1000/5	10	10	10	10	1			
	1200/5	20	20	20	20	1			
	1500/5	20	20	20	20	1			
	2000/5	40	40	40	40	1			
	500/1	10	10			1			
	600/1	10	10			1			
	750/1	10	10			1			
	800/1	10	10			1			
	1000/1	10	10			1			
	1200/1	20	20			1			
	1500/1	20	20			1			

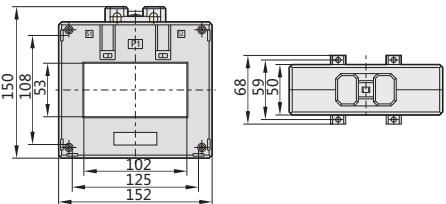
A

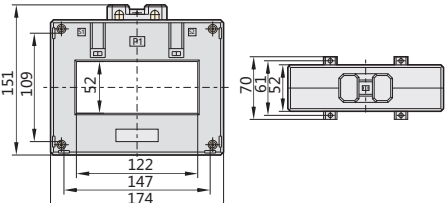
	电流比A	额定输出VA(二次电流1A : Ω)				穿心匝数	外形及安装尺寸		
		1级	0.5级	0.5S级	0.2级				
 <p>BH-0.66 80 III</p>	500/5	10	10	10	10	1			
	600/5	10	10	10	10	1			
	750/5	10	10	10	10	1			
	800/5	10	10	10	10	1			
	1000/5	10	10	10	10	1			
	1200/5	20	20	20	20	1			
	1500/5	20	20	20	20	1			
	2000/5	40	40	40	40	1			
	2500/5	40	40	40	40	1			
	500/1	10	10			1			
	600/1	10	10			1			
	750/1	10	10			1			
	800/1	10	10			1			
 <p>BH-0.66 100 III</p>	1000/5	10	10	10	10	1			
	1000/5	10	10	10	10	1			
	1200/5	20	20	20	20	1			
	1500/5	20	20	20	20	1			
	2000/5	40	40	40	40	1			
	2500/5	40	40	40	40	1			
	800/1	10	10			1			
	1000/1	10	10			1			
	1200/1	20	20			1			
	1500/1	20	20			1			
	2000/1	40	40			1			
	 <p>BH-0.66 120 III</p>	1000/5	10	10	10	10		1	
		1200/5	20	20	20	20		1	
1500/5		20	20	20	20	1			
2000/5		40	40	40	40	1			
2500/5		40	40	40	40	1			
3000/5		40	40	40	40	1			
4000/5		40	40	40	40	1			
1000/1		10	10			1			
1200/1		20	20			1			
1500/1		20	20			1			
2000/1		40	40			1			
2500/1		40	40			1			
3000/1		40	40			1			

## 5 安装附件

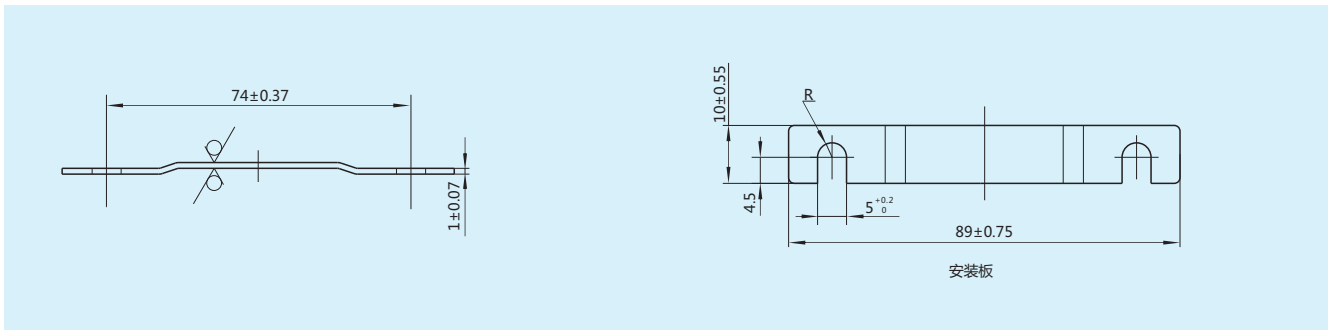

## 6 订货须知

用户在订货时，需提供以下信息：

- 6.1 产品型号及窗口宽度；
- 6.2 额定电流比；
- 6.3 额定输出及相应准确级；

例如：订货BH-0.66 III 型，窗口宽度为30mm，额定电流比200/5A、额定输出5VA、准确级0.5级的互感器。

订货代号为：BH-0.66 30III 200/5A 5VA 0.5级。

- 6.4 如有特殊要求时，可与厂家协商定制。